

# OTAVO



# OTAVO Q&R

by PIETRO LOVATO

Otavo è una famiglia di sedie che incarna l'essenza della seduta operativa da ufficio. Con due versioni disponibili, offre comfort e praticità, ergonomia e resistenza all'uso. L'ampia scelta di colori e materiali lo rende facilmente adattabile a ogni tipo di contesto lavorativo.

*The Otavo family expresses the essence of task chairs. With its two variants, it offers the users comfort and functionality, ergonomics and durability. A wide range of colours and materials are available for it to integrate with virtually any kind of work space.*

Girevole, supporto lombare e altezza schienale regolabili.  
Versione Q: imbottita. Poggiatesta opzionale.  
Versione R: schienale tappezzato.

Swivel, adjustable lumbar support and backrest height.  
Q version: padded backrest. Optional headrest.  
R version: Upholstered backrest.



M

144



145



OTAVO Q



OTAVO R



# OTAVO Q

Medium

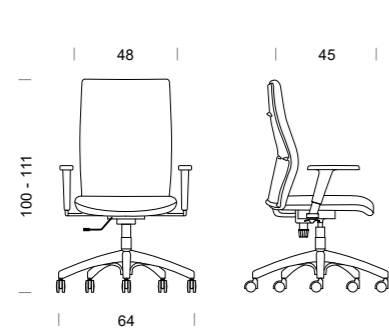

Medium+headrest

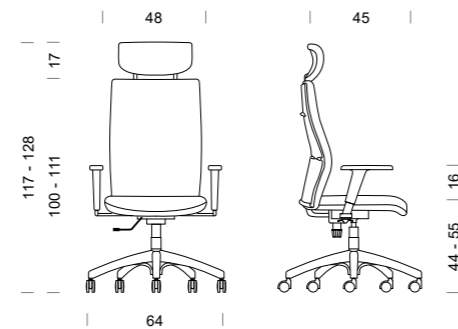

**SCHIENALE:** Schienale regolabile in altezza (6cm) in polipropilene, finitura nera imbottito con spugna e rivestita in tessuto, con sostegno in tubo rettangolare d'acciaio, 60x20mm, finitura verniciata a polveri.

**BACKREST:** Black polypropylene height adjustable backrest (6cm), foam padding and fabric upholstery. Rect. 60x20mm steel tube support, powder coated.

**DOSSIER:** Dossier réglable en hauteur (6cm) en polypropylène, finition noir rembourré de mousse et tapissé, avec soutien en tube d'acier rectangulaire, 60x20mm, finition verni époxy.

**RÜCKENLEHNE:** (6cm) Höhenverst. schwarze polypropylen Rückenlehne mit Schaumstoff, ausgepolstert. Vierkantstahlrohrstütze 60x20mm, pulverbeschichtet.

**RESPALDO:** Respaldo ajustable en altura (6 cm) en polipropileno, acabado negro acolchado con espuma y forrado en tela, con soporte en tubo de acero rectangular, 60x20 mm, acabado en polvo.

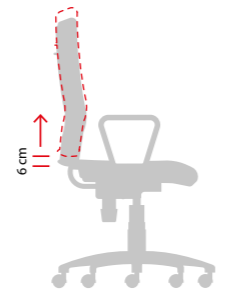

Schienale regolabile in altezza  
Height adjustable backrest  
Dossier réglable en hauteur  
Höhenverst. schwarz  
Respaldo ajustable en altura



SynchroPlus  
TECH INSIDE. SIMPLE OUTSIDE  
Slide

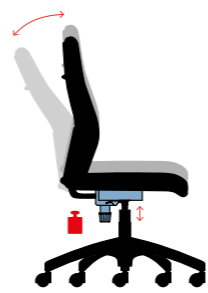

MiniSynchro

# OTAVO R

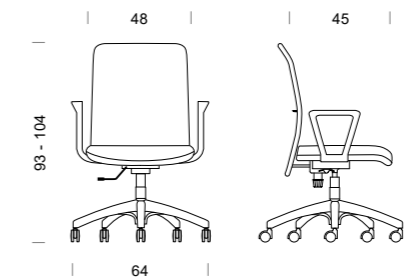

**SCHIENALE:** Schienale in tubo tondo d'acciaio, Ø 20 mm, finitura vern. a polveri rivestito in rete o tappezzato.

**BACKREST:** Ø 20mm steel round bar backrest, powder coated, mesh or upholstered.

**DOSSIER:** Dossier en tube d'acier rond, Ø 20mm, finition verni époxy, revêtu en résille ou rembourré.

**RÜCKENLEHNE:** Ø 20mm Stahlrohr Rückenlehne pulverbeschichtet, ausgepolstert oder Netzbezug.

**RESPALDO:** Respaldo en tubo de acero redondo, Ø 20 mm, acabado pintado polvo cubierto con malla o tapizado.

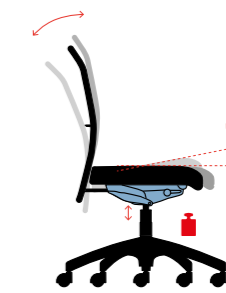

SynchroPlus  
TECH INSIDE. SIMPLE OUTSIDE  
Slide

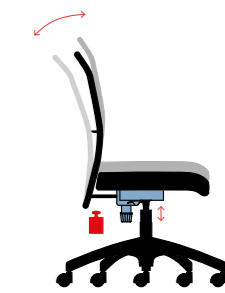

MiniSynchro



5-spoke polyamide base



Ø 50 mm self-braking, black finish



Ø 50 mm soft self-braking, black finish

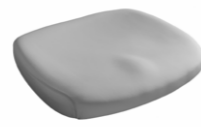

XD017 comfort seat



XM007 seat with negative inclination ONLY for SYNCHRO PLUS



5-spoke polyamide base



Ø 50 mm self-braking, black finish



Ø 50 mm soft self-braking, black finish

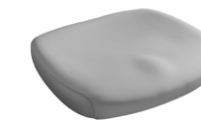

XD017 comfort seat

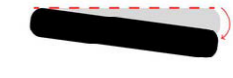

XM007 seat with negative inclination ONLY for SYNCHRO PLUS

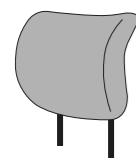

XT008 headrest



XB070 polyamide arm.



XB020 - 2D  
XB021 - 3D

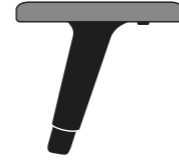

XB022 - 2D soft pad  
XB023 - 3D soft pad



XB089 - 4D extra soft pad

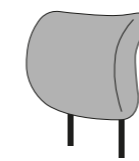

XT008 headrest



XB070 polyamide arm.



XB020 - 2D  
XB021 - 3D

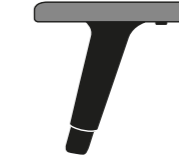

XB022 - 2D soft pad  
XB023 - 3D soft pad

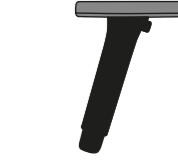

XB089 - 4D extra soft pad

