

# ECOCHAIR



# ECOCHAIR



# ECOCHAIR

by PIETRO LOVATO

Ecochair è la seduta operativa di domani, ed è già qui. Il know-how tecnologico di Moving è investito in una sedia ergonomica dalle linee sobrie, costruita intorno all'idea di funzionalità. Lo schienale in rete e l'adattabilità a ogni tipo di corporatura la rendono particolarmente confortevole, mentre una scelta consapevole dei materiali ne fanno un prodotto riciclabile al 98,5%.

*Ecochair is the task chair of tomorrow, and it's already here. Moving's technological expertise shows in this ergonomic seat which is crafted with functionality in mind. Linear design, mesh backrest and a high level of adaptability to different body types make Ecochair always comfortable, while a conscious choice of materials allow to recycle up to 98,5% of this product.*

Girevole. Poggiatesta opzionale.  
Supporto lombare regolabile.

*Swivel. Optional headrest.  
Adjustable lumbar support.*

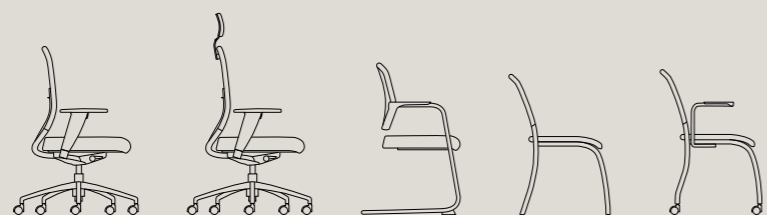

M





# ECOCHAIR



CUSCINO EXTRA COMFORT  
EXTRA-COMFORT CUSHION





# ECOCHAIR



ECOCHAIR



ECOCHAIR





# ECOCHAIR



# ECOCHAIR

Medium

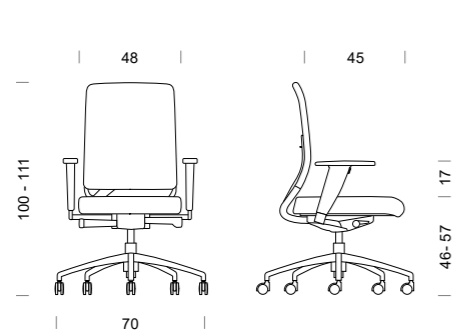

Medium+headrest

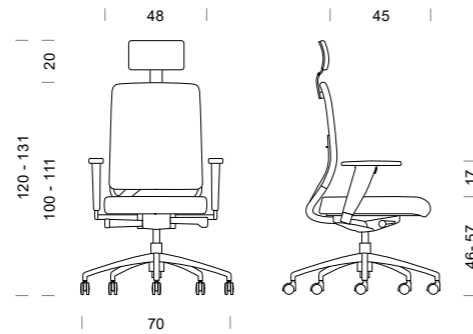

**SCHIENALE:** Schienale in poliamide con carica di fibra di vetro, finitura nera o bianca, rivestito in rete, con poggiatesta integrato.

**BACKREST:** Fiberglass reinforced polyamide backrest, black or white finish, upholstered in mesh, integrated lumbar support.

**DOSSIER:** Dossier en polyamide renforcé en fibre de verre, finition noir ou blanche, en résille, avec soutien lombaire intégré.

**RÜCKENLEHNE:** Schwarze oder weiße glasfaserverstärktes Polyamid Rückenlehne, mit Netzbespannt, mit integriert Lumbalstütze.

**RESPALDO:** Respaldo de poliamida con carga de fibra de vidrio, acabado negro o blanco, malla, con soporte lumbar integrado.



5-spoke aluminium base



5-spoke polyamide base



5-spoke design polyamide base



Ø 50 mm self-braking, black finish



Ø 50 mm soft self-braking, black finish



# ECOCHAIR



**XB091** - chromed 2D  
**XB092** - chromed 3D



**XB020** - 2D  
**XB021** - 3D

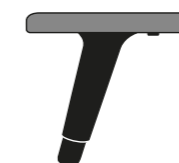

**XB022** - 2D soft pad  
**XB023** - 3D soft pad

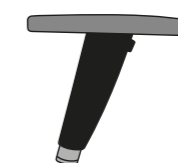

**XB094** - chromed 2D soft pad  
**XB087** - chromed 3D soft pad



**XB089** - 4D extra soft pad

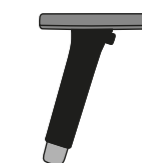

**XB090** - chromed 4D extra soft pad

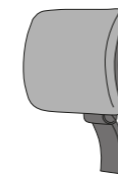

headrest **XT007**

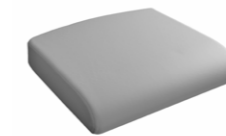

**XD018** comfort seat



**XM007** seat with negative inclination ONLY for SYNCHRO PLUS



**XD001** seat with springs



# ECOCHAIR

## Visitor

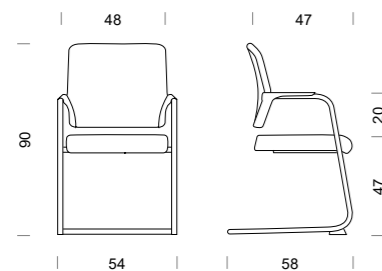

## 4-legs

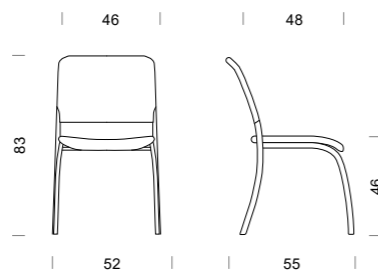

## 4-legs castors

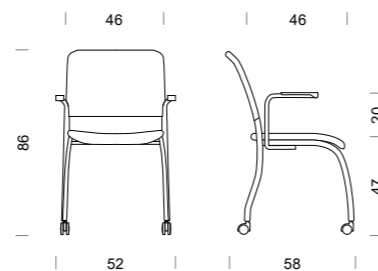

### SCHIENALE:

Schienale in poliamide con carica di fibra di vetro, finitura nera, o schienale in tubo d'acciaio integrato alla base, rivestito in rete.

### BACKREST:

Fiberglass reinforced polyamide backrest, black finish. Base integrated steel tube backrest, mesh upholstered.

### DOSSIER:

Dossier en polyamide renforcé en fibre de verre, finition noir, en résille.

### RÜCKENLEHNE:

Freischwinger mit Polyamid Rückenlehne, 4-Fuß mit Metall Rückenlehne, mit Netzbespannt.

### RASPALDO:

Respaldo de poliamida reforzada con fibra de vidrio, acabado negro o parte posterior de tubo de acero integrada en la base, malla.

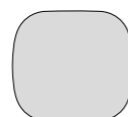

Sedile rotondo  
Round seat  
Assise arrondie  
Sitz rund  
Asiento redondo



Sedile squadrato  
Square seat  
Assise carrée  
Sitz eckig  
Asiento cuadrado



Visitor base with arms



4-legs base



4-legs on castors base



**XA003** - short  
**XA004** - long  
linking device



polyamide glides  
black with felts



plugs  
polypropylene



Ø 50 mm  
self-braking,  
black finish



Ø 50 mm  
soft self-braking,  
black finish



**XB043** - grey  
**XB044** - chromed  
**XB045** - black

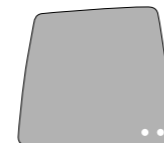

**XS003**  
writing tablet  
22x28 cm

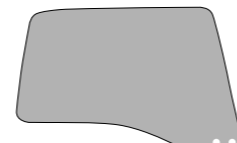

**XS005**  
writing tablet  
33x38 cm



ID 1111209612